

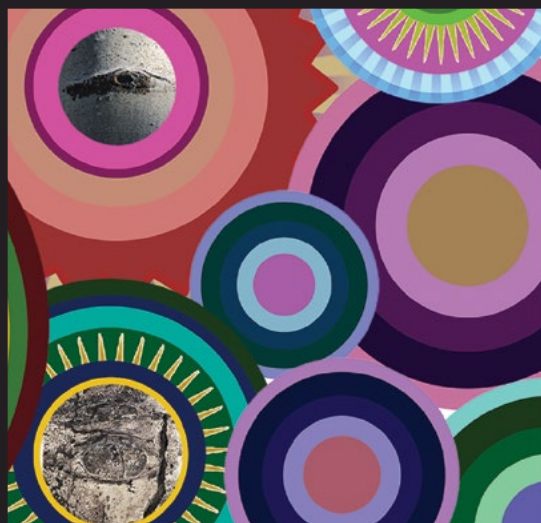

THE ART BEHIND
THE
CABINS
at
MOUNTAIN VILLAGE
A COLORING BOOK

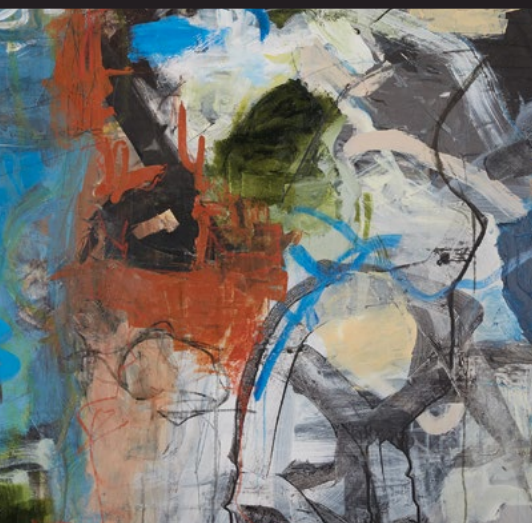



The Town of Mountain Village, the Telluride Mountain Village Owners' Association and Telluride Arts collaborated with local artists to design vinyl wraps for eleven of the refurbished gondola dining cabins scattered throughout the Village Center.



The Telluride Mountain Village Gondola celebrates its 25th anniversary season this winter!

A quarter century ago, the gondola was opened to connect Mountain Village and Telluride and reduce emissions as the Telluride Ski Resort expanded.

December 2021 marks the gondola's 25th birthday!

The gondola is one of the most unique forms of public transportation connecting Mountain Village to Telluride. Approximately 3 million passengers ride the gondola each year and the gondola has offered more than 50 million passenger trips since it opened 25 years ago.

ABOUT THE ARTIST

ABBY J. FOX

Abby J. Fox is an illustrator, painter and printmaker who prioritizes analog art in the digital world. Fox is inspired by travel, and in 2019 she left her heavy printmaking tools at home to take her sketchbook on a trip around the world. She has since worked to expand her illustrative approach to making art and emphasizes plein air practice and drawing from life.

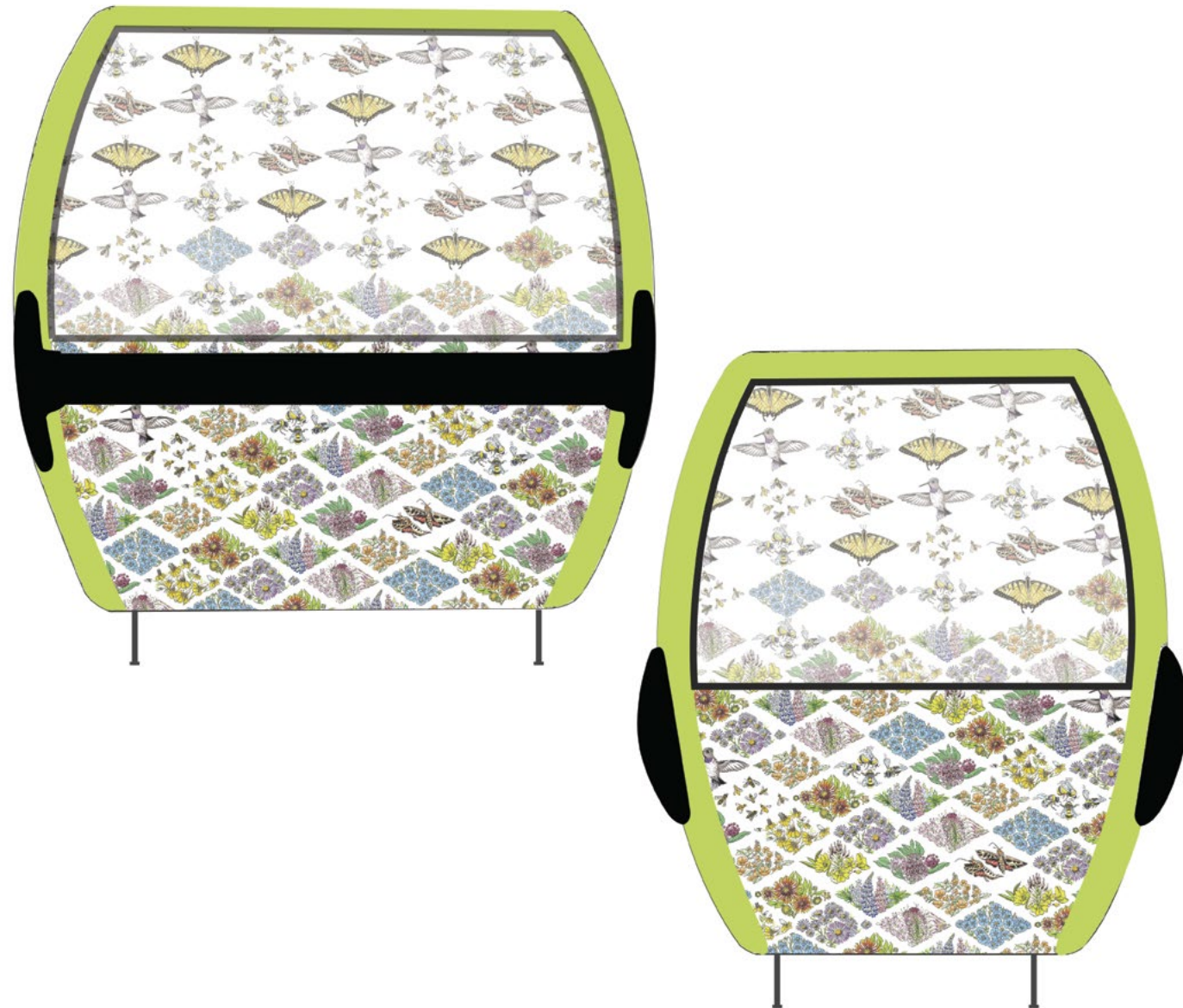

INSPIRED BY *You*

Abby draws animals, bugs and plants that she sees in nature.

Can you draw something that you see outside today?

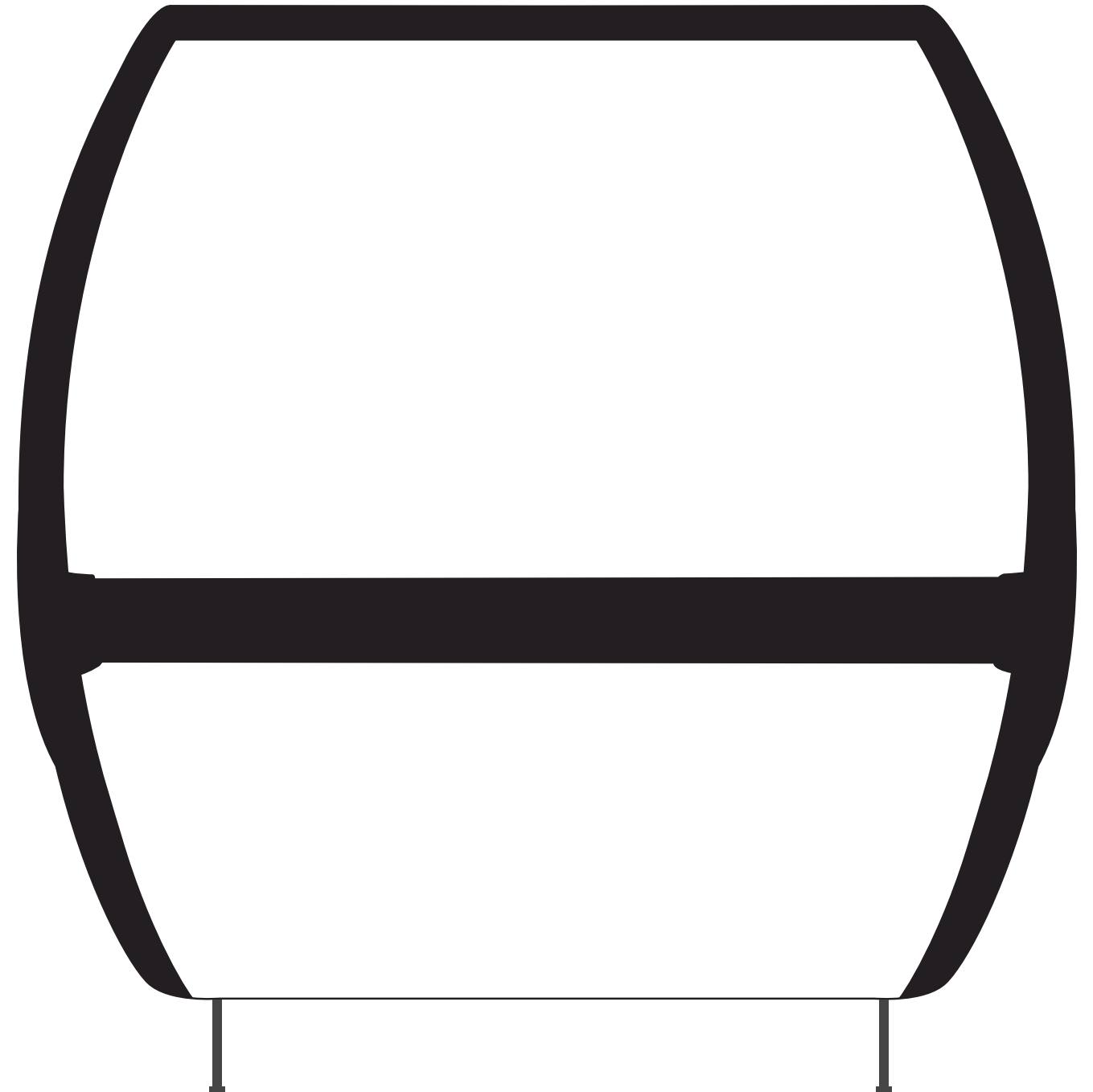

LOCATED IN HERITAGE PLAZA

INSPIRED BY *You*

Shannon draws pictures with colors and animals to tell a story from her imagination.

Can you make a drawing using lots of colors and animals that tells a story from your imagination?

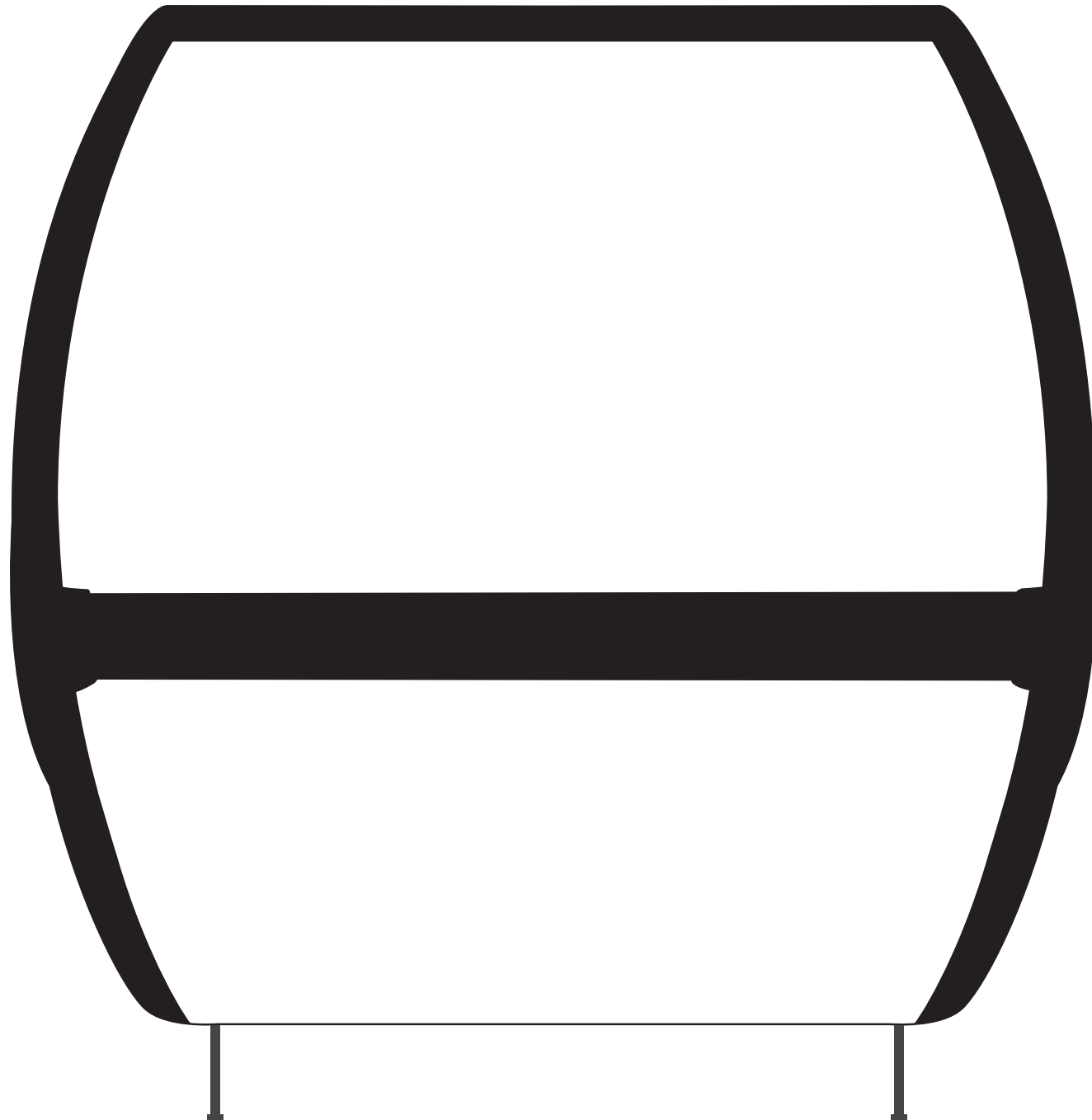

ABOUT THE ARTIST

SHANNON RICHARDSON

Shannon Richardson is an artist from Paonia, CO where she uses her dreams to inspire her art. In college she studied the classical techniques of old art masters in Rome, Italy. Ever since, she has been showing her art professionally with it exhibited in homes and galleries around the world.



ABOUT THE ARTIST

MARGARET RINKEVICH

Margaret Rinkevich is an artist and the owner of Rinkevich Gallery. She has been dedicated to the arts most of her life. Throughout her career, she has participated in archaeological excavations in Italy, taught art history, researched museum acquisitions, lectured museum docents, worked at contemporary art galleries, authored publications and juried art shows. Rinkevich Gallery opened in Mountain Village in 2018 and features her abstract paintings along with tribal sculpture. Her work hangs in numerous private collections throughout the United States.



3

LOCATED IN HERITAGE PLAZA

INSPIRED BY *You*

Margaret uses lots of colors, lines and shapes in her paintings.

Can you make a drawing using lots of colors, lines and shapes?

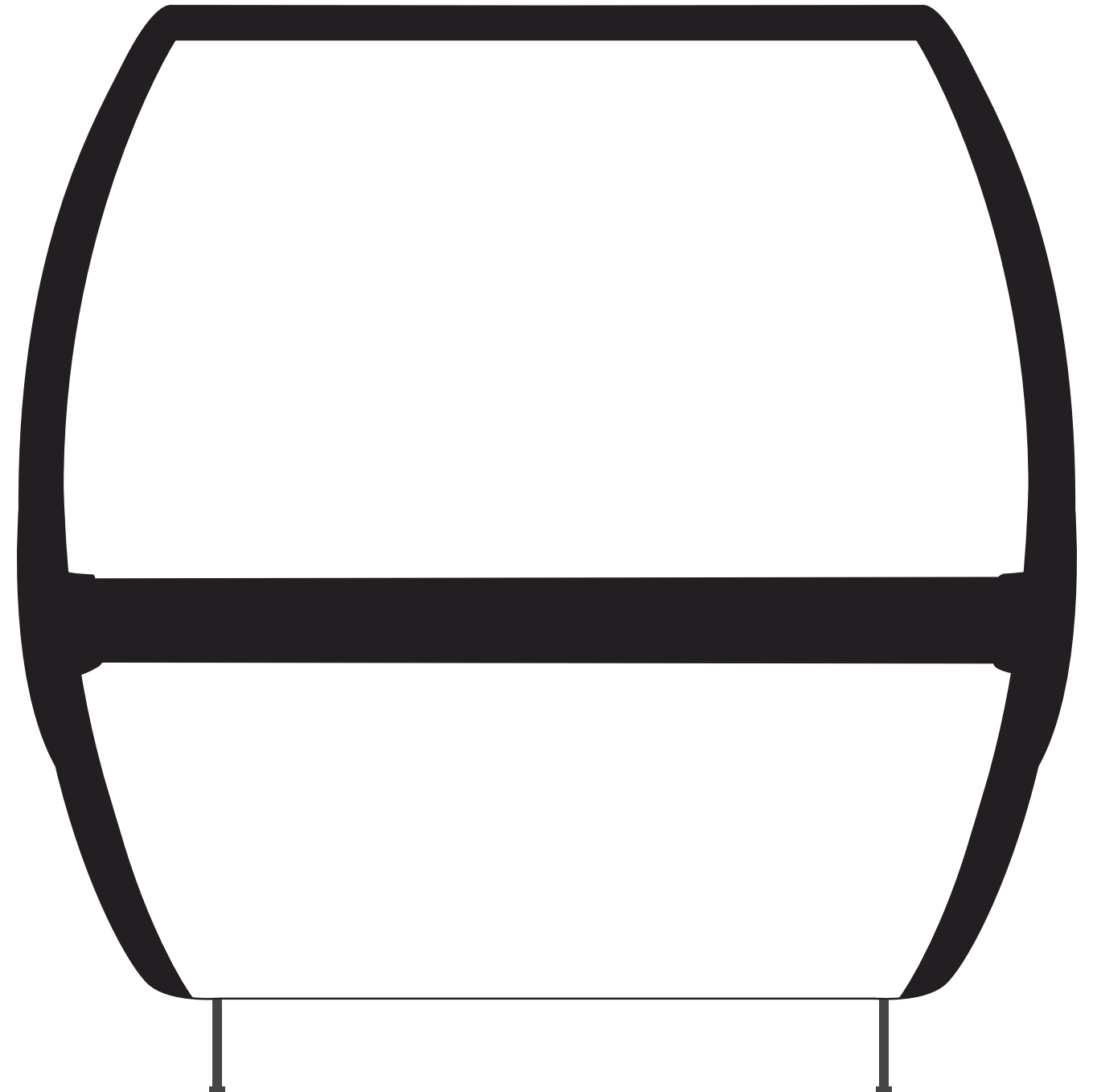

INSPIRED BY *You*

Robin draws pictures of chickens using lots of bright colors.
Can you draw a picture of a chicken, or another animal that you love,
using lots of bright colors?

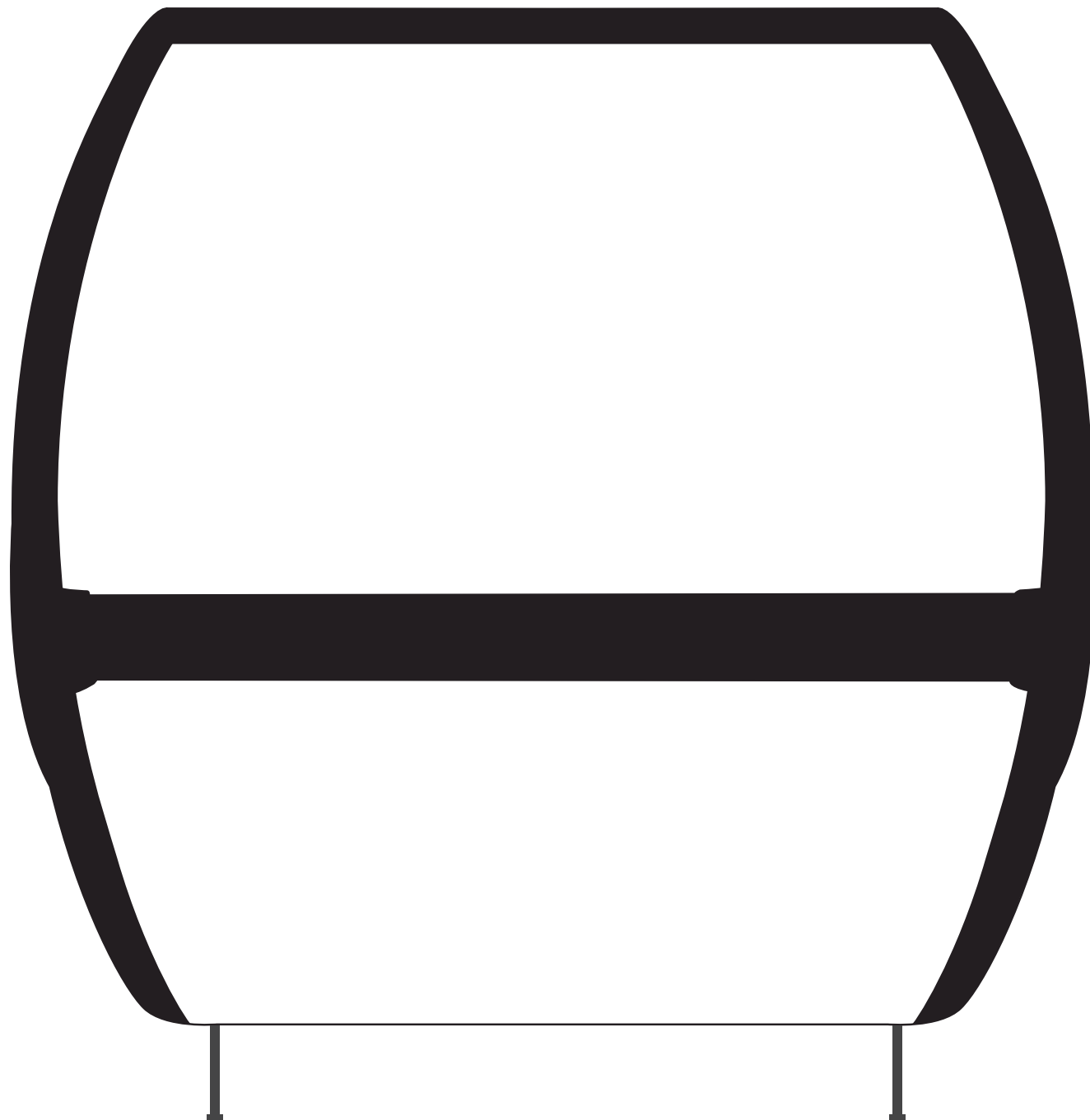

ABOUT THE ARTIST

ROBIN ARTHUR

Robin Arthur creates bright, happy, custom pet portraits from high on a mesa overlooking the beautiful North Fork Valley and the town of Paonia. From there, she paints custom pet portraits, mid-century-modern-inspired abstracts and Colorado landscapes. She loves to paint chickens because they are, "quirky, funny creatures that exude comfort and are a joy to paint in wild, crazy colors."



ABOUT THE ARTIST

EMILY BALLOU

Emily Ballou, a Telluride local, hails from Texas and gives a nod to both the opportunity and the inspiration she has found during her years in the San Juans. Ballou uses acrylics, inks and gold leaf mediums primarily, focusing on texture and dimension in her works.



INSPIRED BY *You*

Emily uses lots of colors and textures in her paintings.
Can you make a drawing that uses lots of colors and textures?

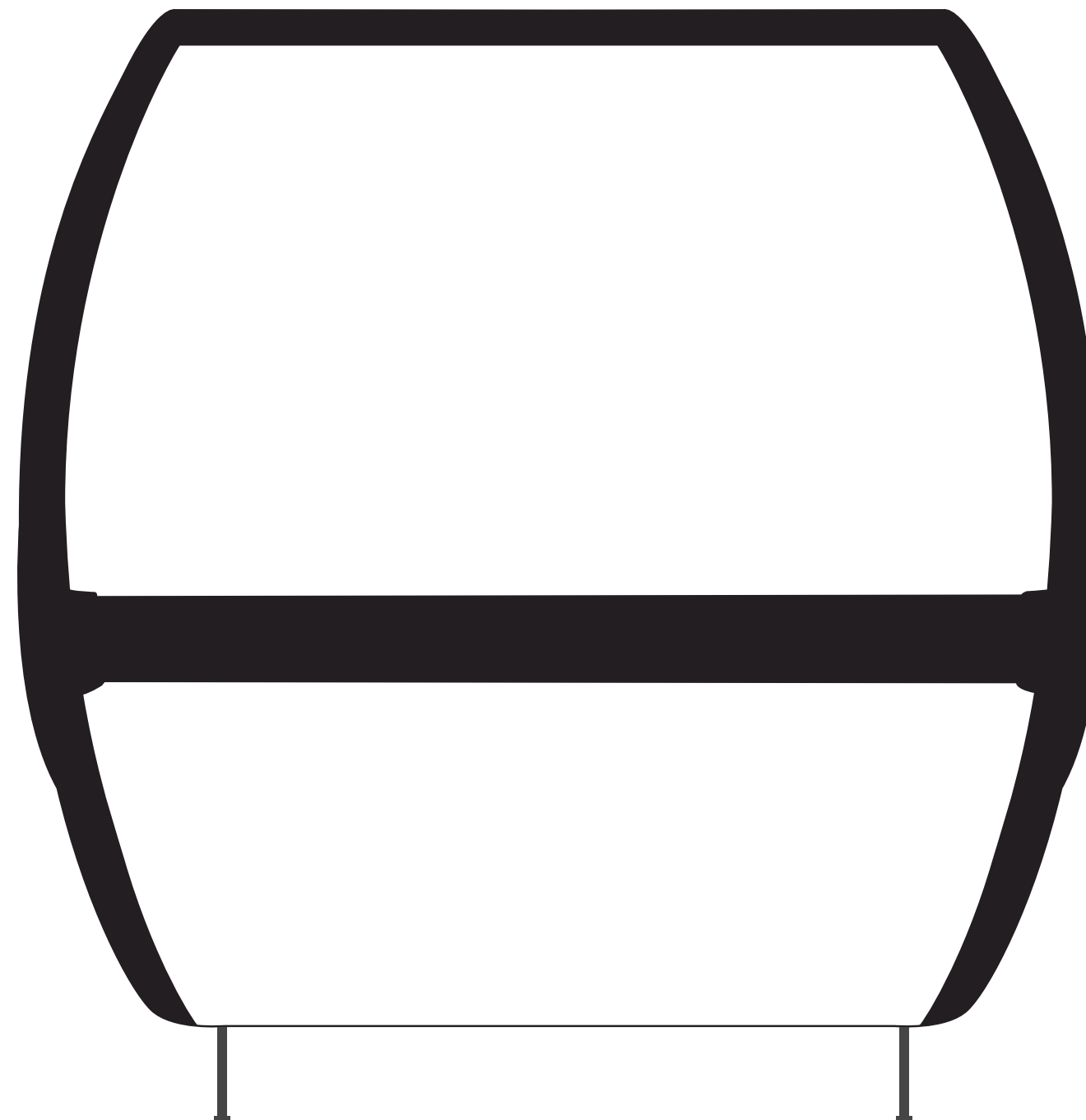

5

LOCATED IN HERITAGE PLAZA

THE
CABINS
at
MOUNTAIN VILLAGE

INSPIRED BY *You*

Rosa creates pictures of nature from her imagination.

Can you make a drawing from your imagination about nature, or something you love?

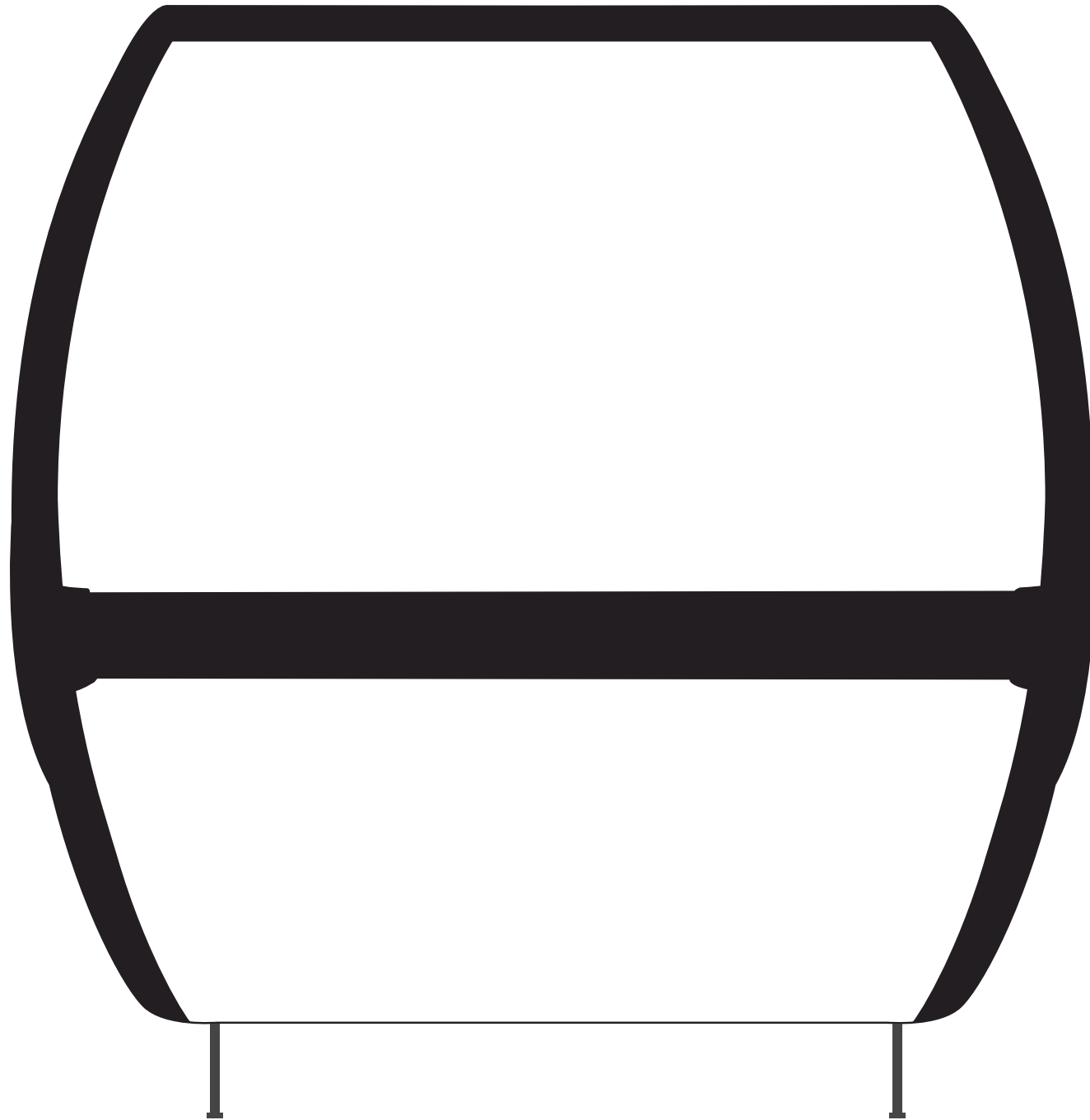

THE
CABINS
at
MOUNTAIN VILLAGE

ABOUT THE ARTIST

ROSA CRUZ

With her art studio, Cruglez Stermann Studio, Rosa Cruz develops designs for various public art projects around the United States. She has dedicated her work to public art initiatives for the beautification of spaces as well as the development of culture and society through art.



6

LOCATED IN HERITAGE PLAZA

ABOUT THE ARTIST

SHERWOOD SMITH

Sherwood Smith is an illustrator born and raised in the San Juan Mountains.



INSPIRED BY *You*

Sherwood draws animals, mountains and trees using just three colors.
Can you make a drawing of animals and trees and mountains using just three colors?

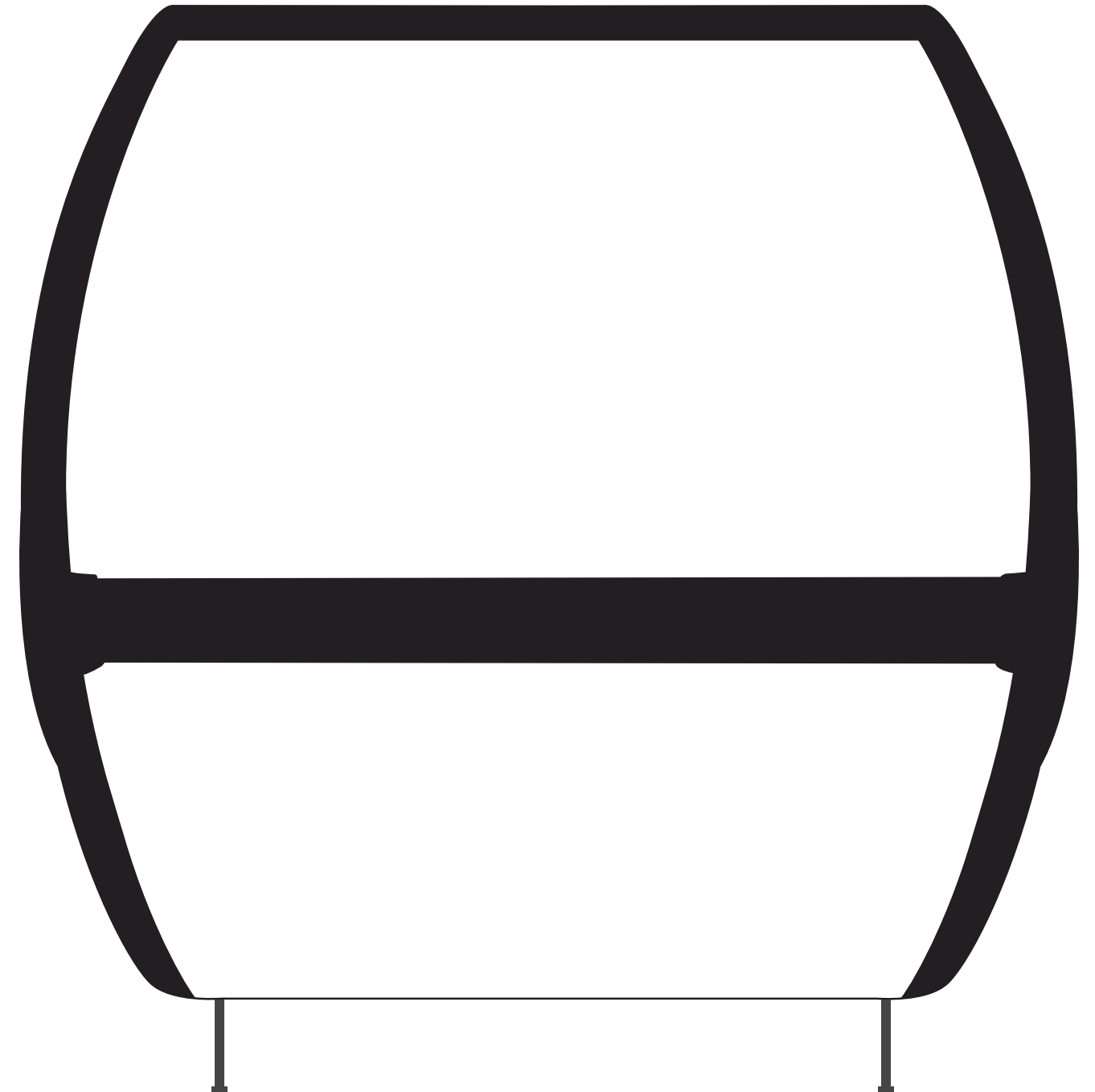

7

LOCATED IN SUNSET PLAZA

THE
CABINS
at
MOUNTAIN VILLAGE

INSPIRED BY *You*

Alexis draws circles with lots of colors and patterns and puts pictures of aspen trees in the center.

Can you make a drawing with lots of circles, colors and patterns?

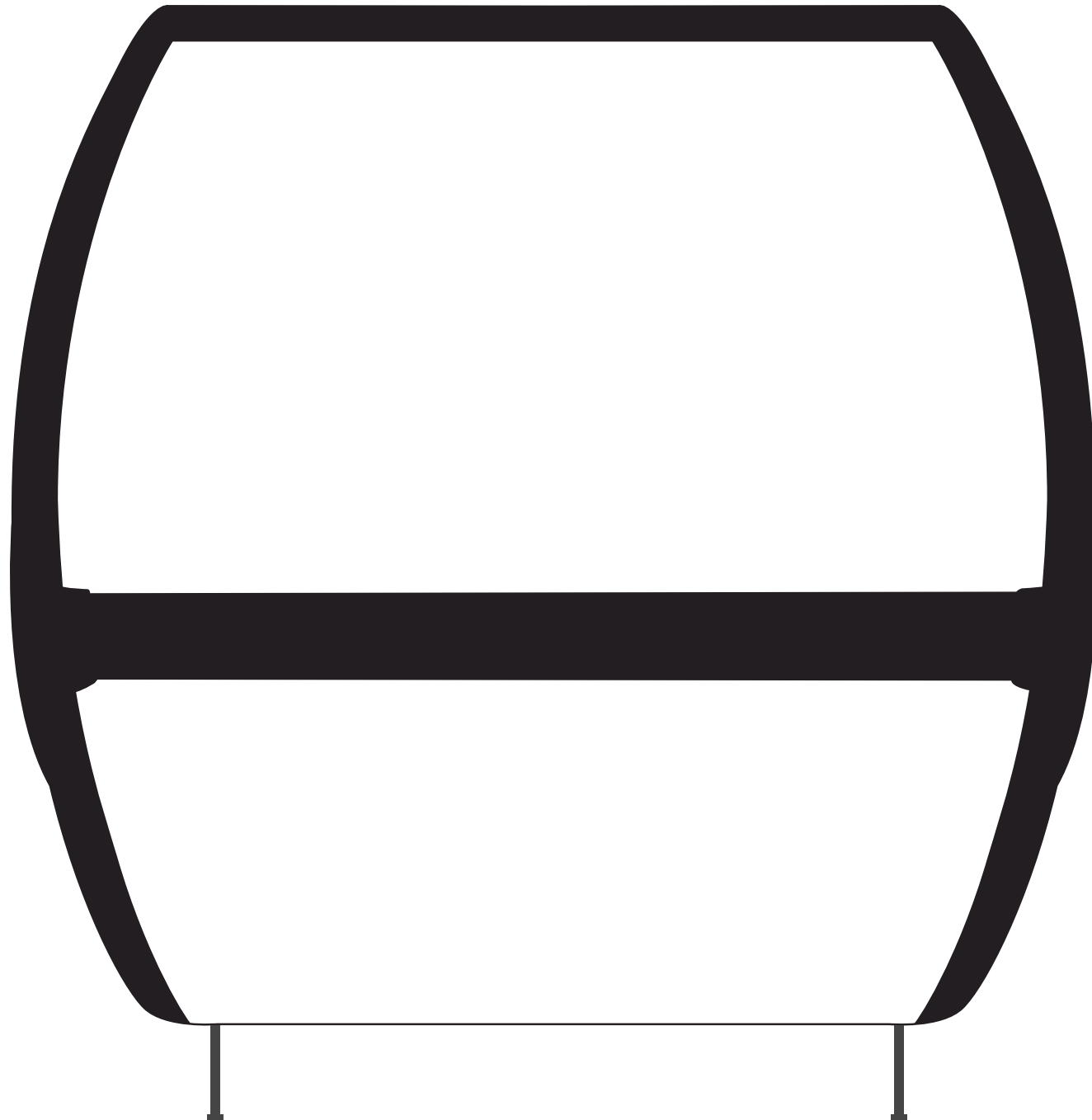

THE
CABINS
at
MOUNTAIN VILLAGE

ABOUT THE ARTIST

ALEXIS ZAMBRANO

Originally from Monterrey, Mexico, Alexis Zambrano has lived and worked in New York City since 2008. Zambrano attended architecture school where he developed his work around space, botanics and spirituality. His paintings and sculptures explore nature, humanity and beyond.



8

LOCATED IN SUNSET PLAZA

ABOUT THE ARTIST

WILLIAM FROWNFEELER

William C. Frownfelter III was born and raised in Telluride and is now based out of Durango, CO. He has worked mostly in graphite and acrylic paint but also dabbles in murals, plein air and more. He continues to bounce from project to project in his free time and plans to engage more in the local plein air and mural community moving forward.

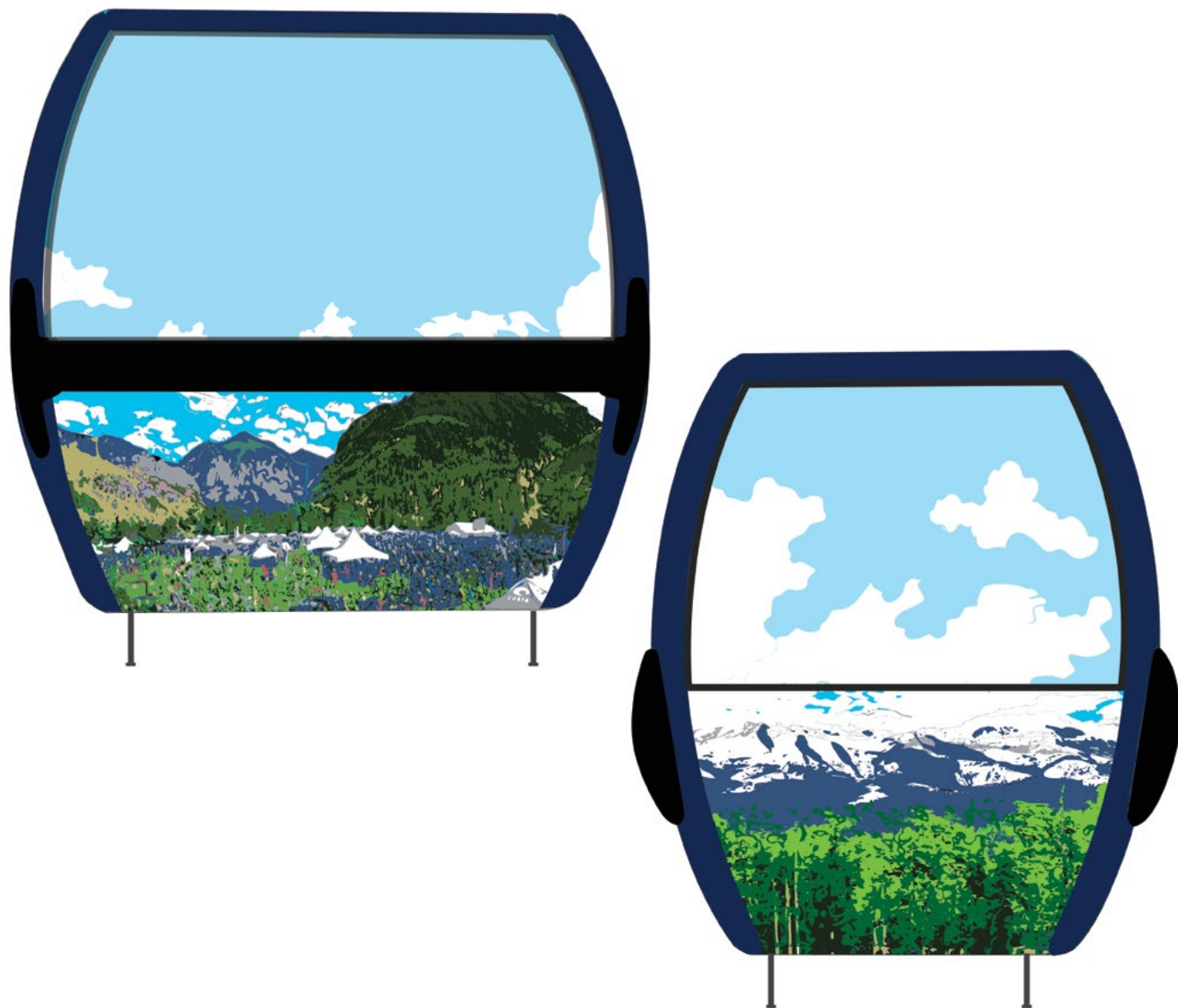

LOCATED IN REFLECTION PLAZA

INSPIRED BY *You*

William draws pictures of things that he loves about Telluride and Mountain Village.

Can you draw a picture of something you love?

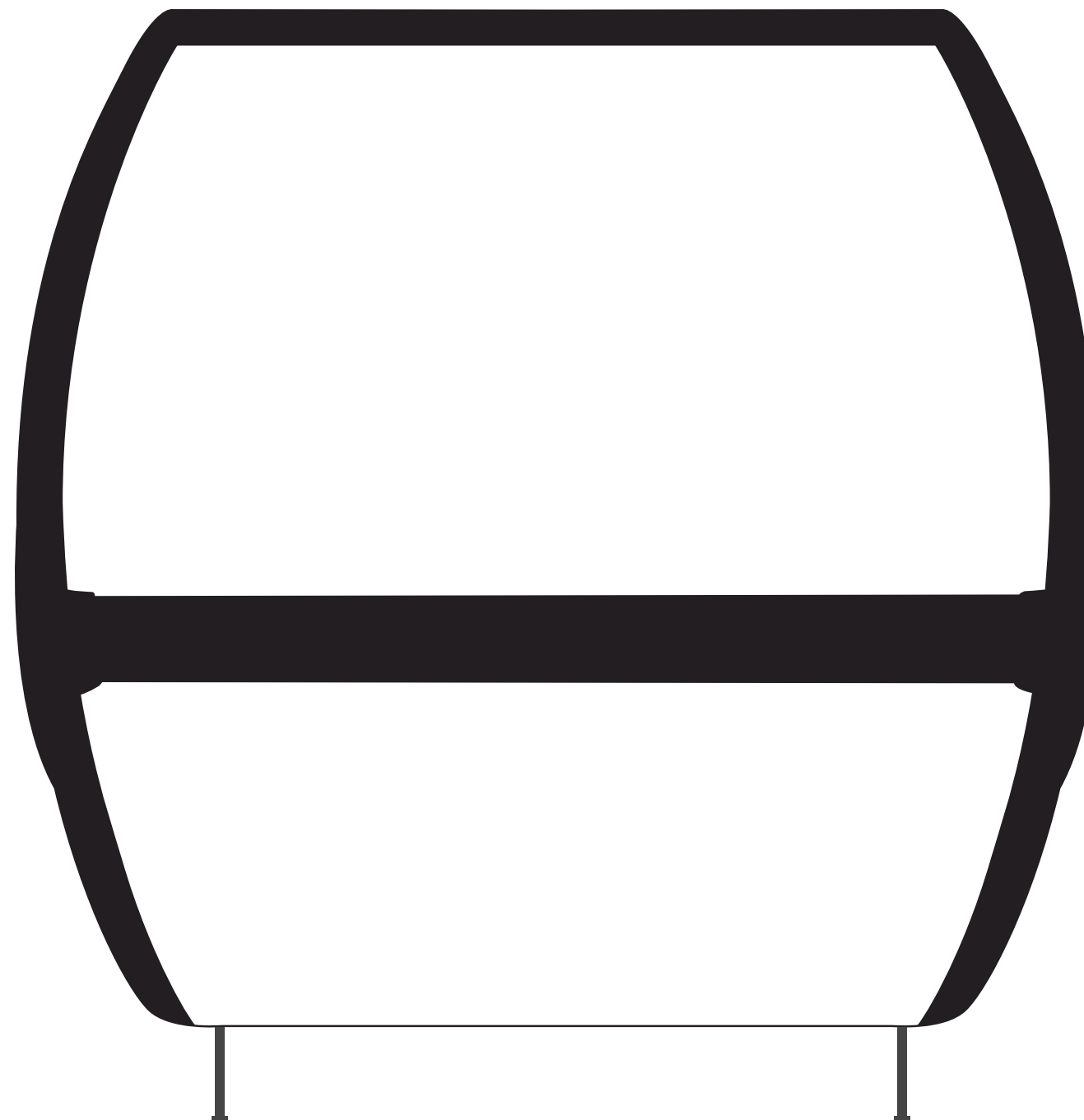

THE
CABINS
at
MOUNTAIN VILLAGE

INSPIRED BY *You*

Emma draws the flowers and mountains around her.

Can you make a drawing of the flowers and mountains around you?

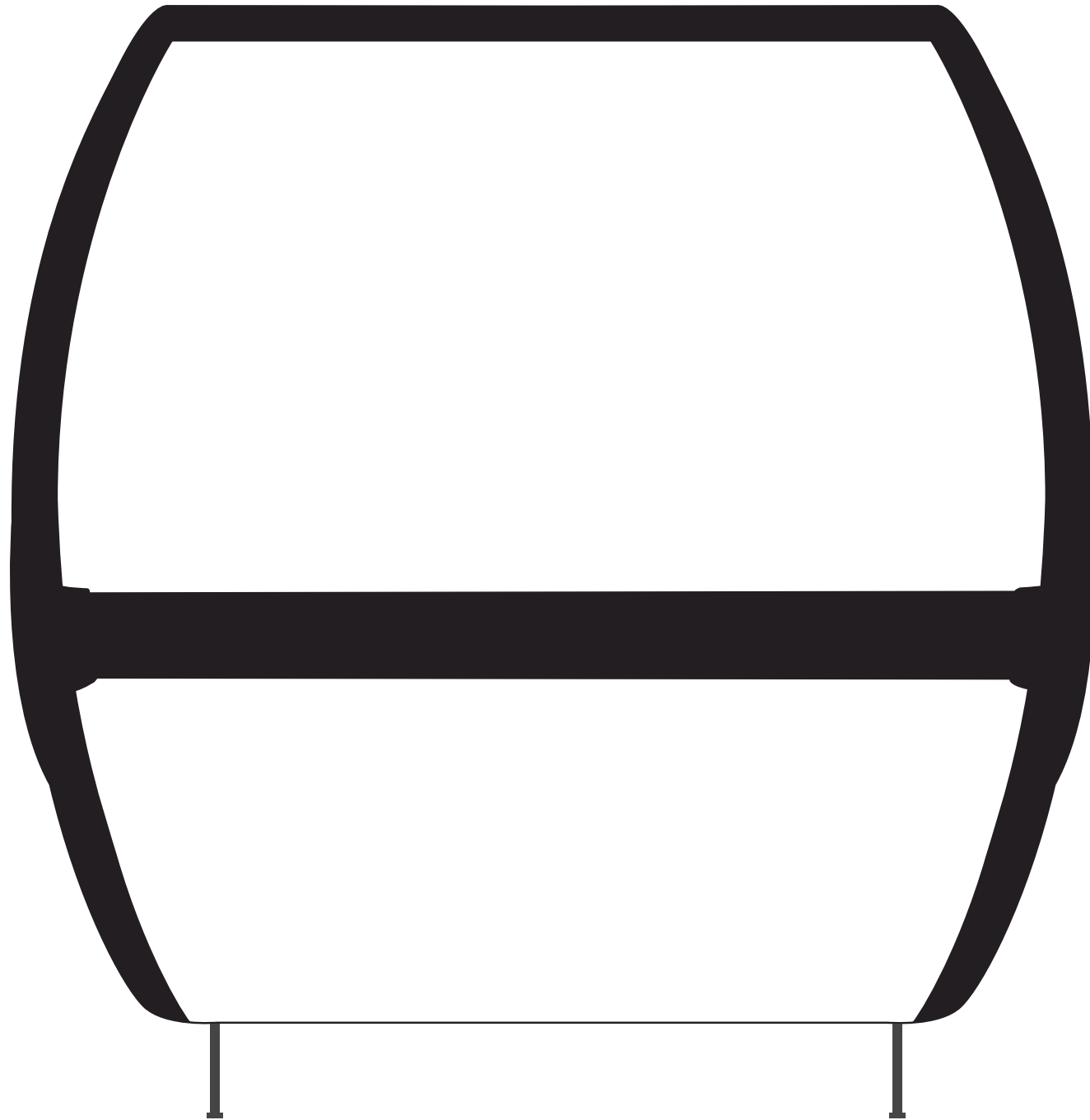

THE
CABINS
at
MOUNTAIN VILLAGE

ABOUT THE ARTIST

EMMA GERONA

Emma Gerona was born and raised in Telluride. She is inspired by the natural beauty of this incredible valley in both her art and her work as the executive director of EcoAction Partners. Even though Gerona is focused on environmental activism in her career, in her spare time, she loves to create art in many forms.

She is excited to share this piece with you, which is inspired by the vibrant colors of the flowers and peaks that we are lucky to look at every day.



10

LOCATED IN VILLAGE POND PLAZA

ABOUT THE ARTIST

CHRISTOPHER WARREN

Christopher Warren (also known as Beatnik Prints) has been exploring Colorado mountains and Utah canyons his whole life. He started experimenting with reinterpreting topographic maps nearly a decade ago. Since then, he has created prints, clothing, animations, murals and sculptures, inspired by the topography of the American West.



INSPIRED BY *You*

Christopher uses lines to show the shapes of mountains and valleys around us.

Can you use lines to show what the ground looks like around you?

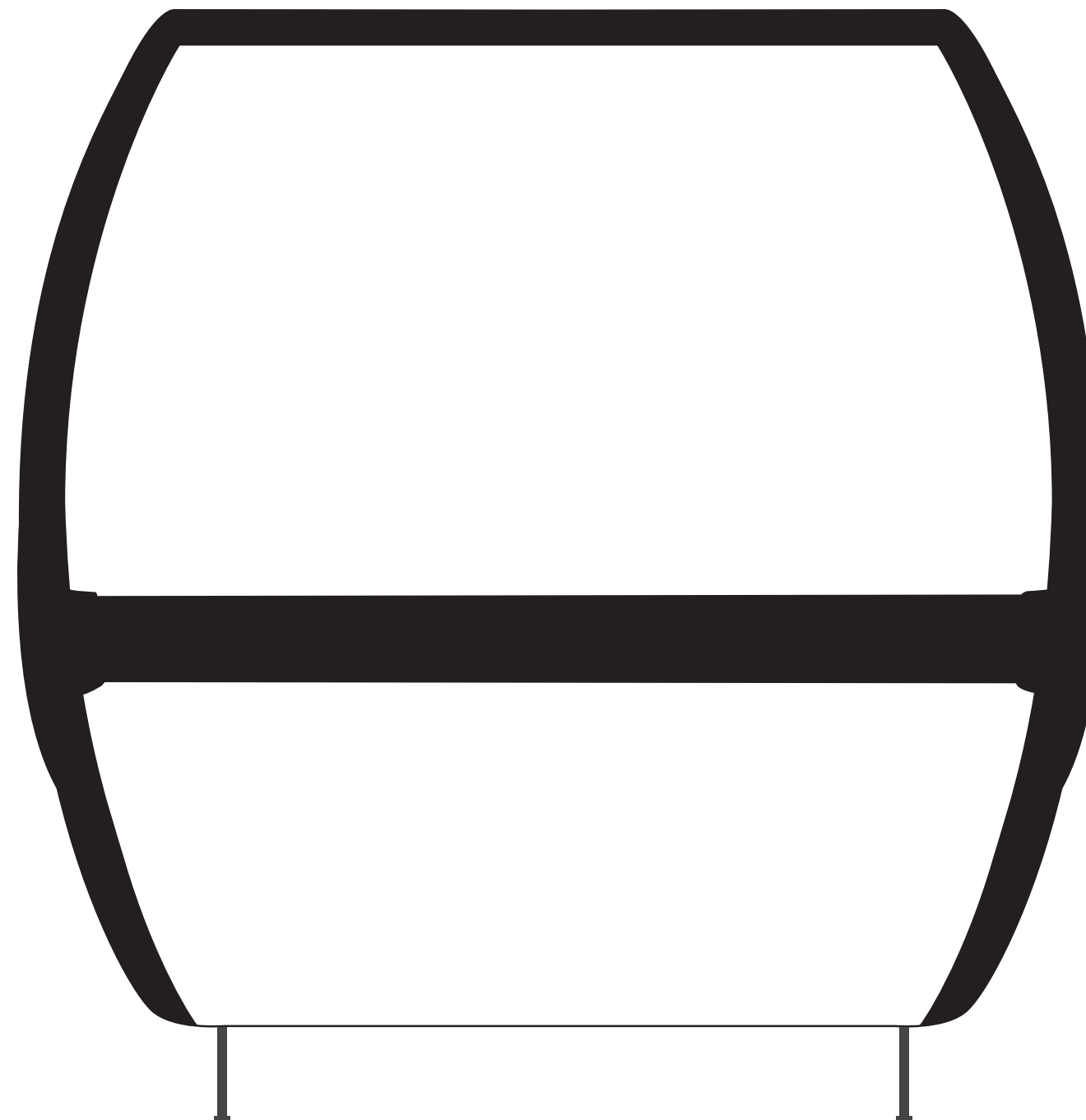

Share your artwork with us
on social media!

Thank you for joining in on the fun!

It was a blast putting this coloring book together for you to enjoy! Please share your masterpieces with us on social media so we can see your artwork!

TAG OUR ACCOUNTS:

@townofmountainvillage @ f

@mountainvillage t

@tellurideartsdistrict f

@telluridearts @ t

#TheCabinsatMV

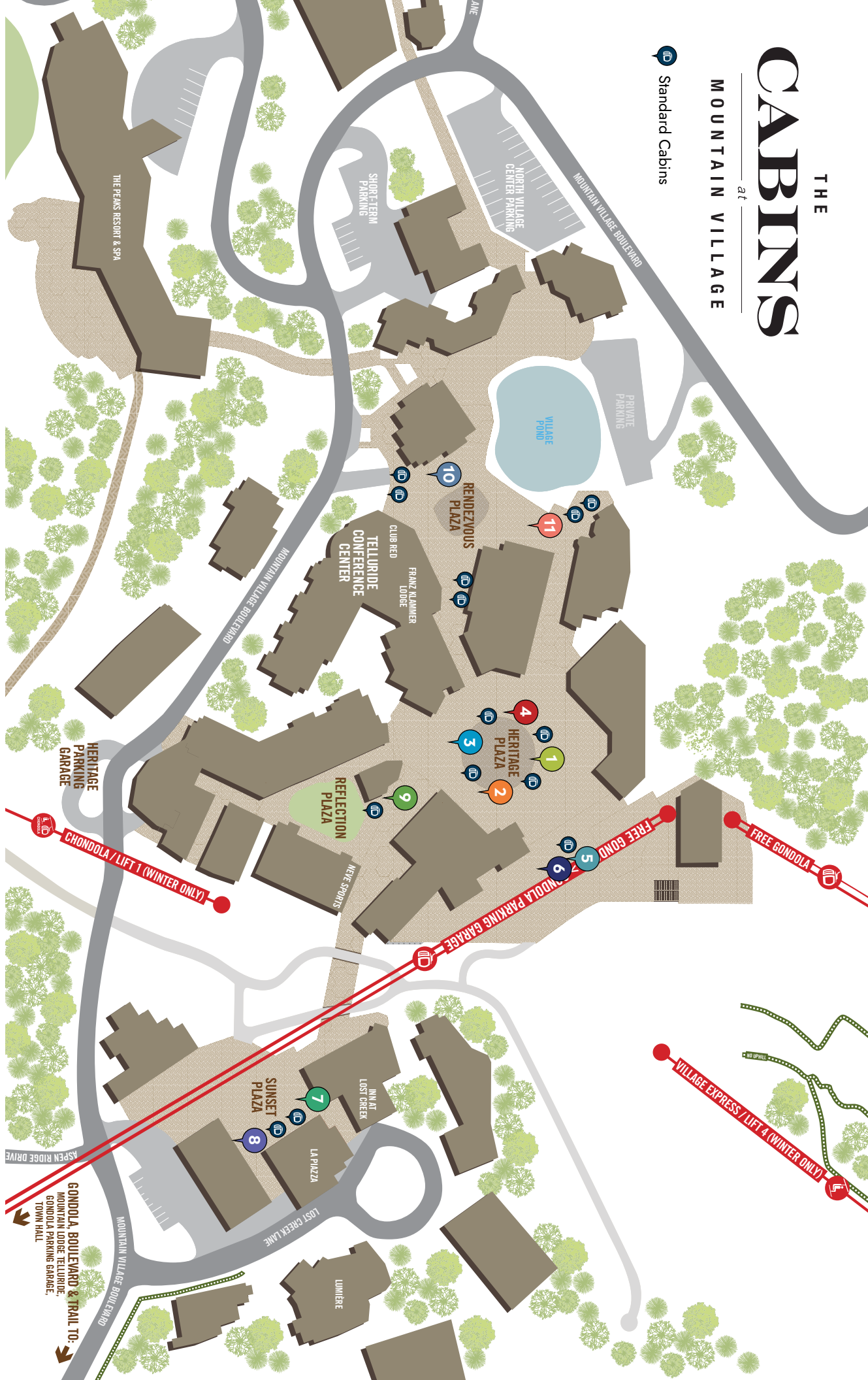
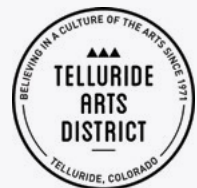

THE CABINS

at

MOUNTAIN VILLAGE

Standard Cabins

MAP KEY

- 1 **ABBY J. FOX**
Heritage Plaza
- 2 **SHANNON RICHARDSON**
Heritage Plaza
- 3 **MARGARET RINKEVICH**
Heritage Plaza
- 4 **ROBIN ARTHUR**
Heritage Plaza
- 5 **EMILY BALLOU**
Heritage Plaza
- 6 **ROSA CRUZ**
Heritage Plaza
- 7 **SHERWOOD SMITH**
Sunset Plaza
- 8 **ALEXIS ZAMBRANO**
Sunset Plaza
- 9 **WILLIAM FROWNFELTER**
Reflection Plaza
- 10 **EMMA GERONA**
Village Pond Plaza
- 11 **CHRISTOPHER WARREN**
Village Pond Plaza



THE
CABINS
— at —
MOUNTAIN VILLAGE



Learn more about The Art Behind The Cabins at Mountain Village
at www.townofmountainvillage.com/thecabins